



AquaTrol®

Rev. 1.45

Troubleshooting Guide



Turbo Cell & Control Electronics

Table of Contents

Important safety instructions	Pg. 1	Display Only, Lights Only or Neither	Pg. 12-15
Switching from Metric to US Standard	Pg. 2	Low/High Cell Temperature	Pg. 16
Changing the Default Reading	Pg. 3	Cell Cleaning instructions	Pg. 17-19
Check Salt/Inspect Cell LED flashing or ON	Pg. 4-5	Pump not turning on	Pg. 20-22
How to Reset Average Salt Level	Pg. 6	Troubleshooting flow charts	Pg. 23-28
Adjusting Chlorine Output	Pg. 7	Salt Chart	Pg. 29
High Salt LED ON	Pg. 8-9	Important Information – Chlorine Output and Salt	Pg. 30
No Flow LED flashing or ON	Pg. 10-11	Reading Serial Numbers	Pg. 31

Aqua Trol Diagnostics

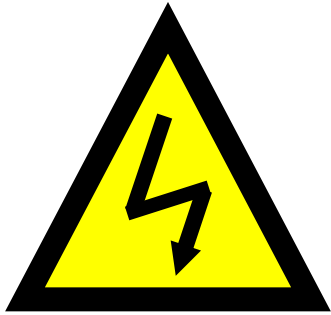

High Voltage Electrocution Hazard

Hazardous voltage can shock, burn, cause serious injury and or death. To reduce the risk of electrocution and or electric shock hazards:

- Only qualified technicians should remove the panel
- Replace damaged wiring immediately
- Insure panel is properly grounded and bonded

Switching from Metric to US Standard

If the first reading (average salt) is showing in decimal form instead of as a number represented in thousands, then the unit has been set to 'Metric Mode'.

Step 1

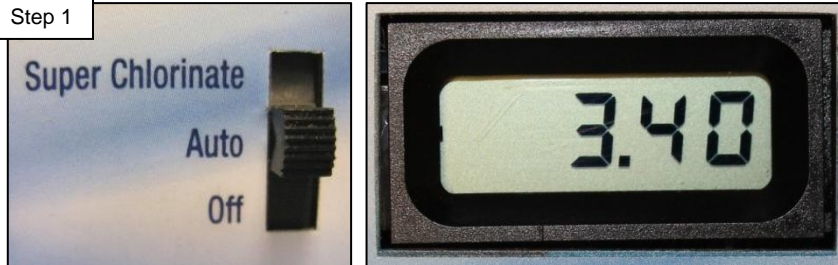

To change the unit from Metric mode to standard, start by pressing the 'Diagnostics' button one time.

Step 2

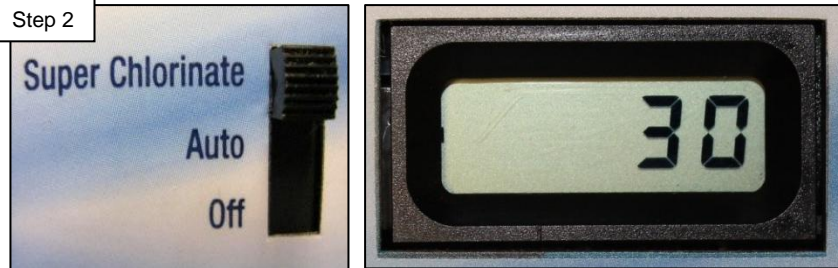

Once showing the temperature in Celsius, move the switch up to 'Super Chlorinate' then back to auto.

Step 3

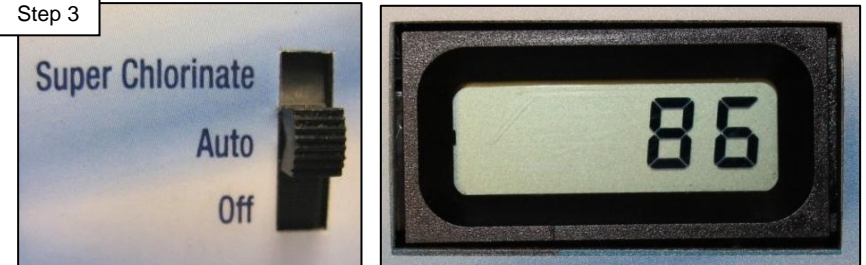

Immediately the temperature reading should change to reflect a Fahrenheit value. If it does not repeat step 2.

Step 4

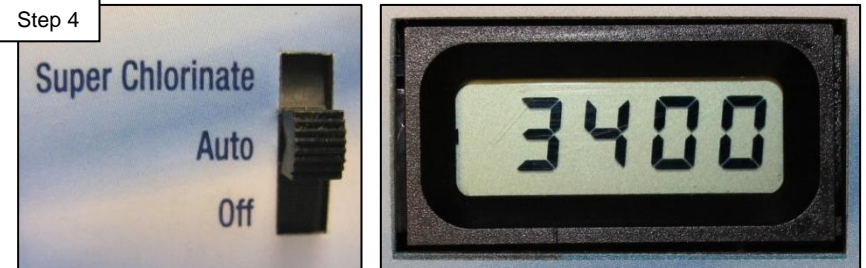

It takes about 30 seconds for the unit to settle back to the default reading. The reading should now reflect a number in thousands.

Changing the Default Display

If the first reading is showing as a number followed by a 'P', then the default reading has been changed to express the 'Desired Output %'.

Step 1

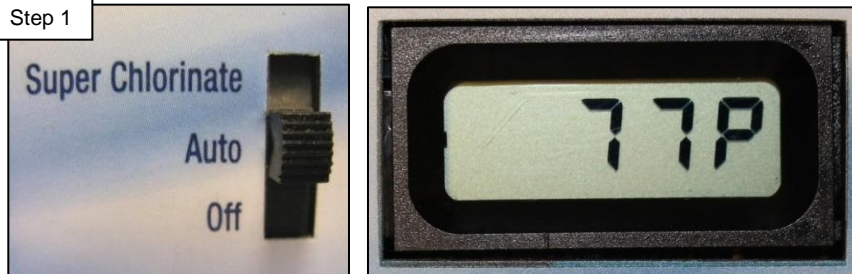

To change the default reading back to the average salt, start by pressing the 'Diagnostics' button one time.

Step 3

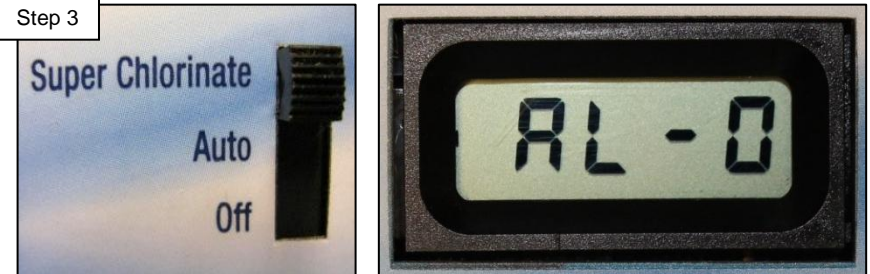

Continue moving the switch up to 'Super Chlorinate' and back to 'Auto' until the unit reads 'AL-0'.

Step 2

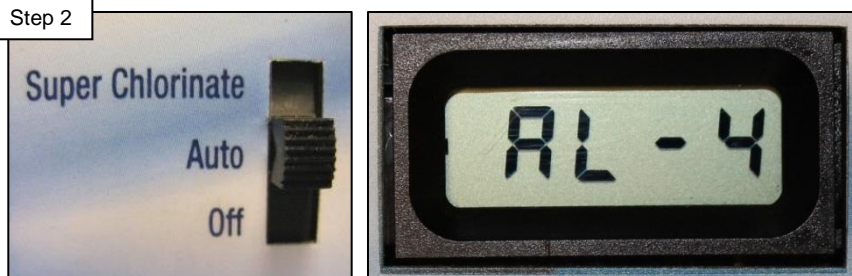

When the unit reads 'AL-4' move the switch up to 'Super Chlorinate' and back to 'Auto'.

Step 4

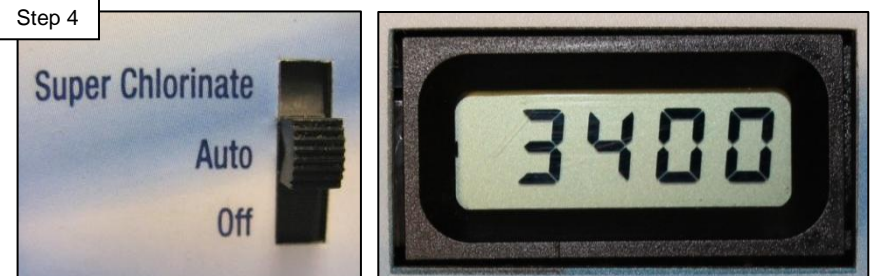

It takes about 30 seconds for the unit to settle back to the default reading. The reading should now reflect the average salt level.

1. Check Salt & Inspect Cell LED flashing or ON

The 'Check Salt' & 'Inspect Cell' LED's will flash when the cell reports the salt level is between 2400-2700ppm. In this condition chlorine is still being produced. The 'Check Salt' & 'Inspect Cell' LED's will be ON when the cell reports the salt level is 2300ppm or less. In this condition, chlorine production is interrupted.

NOTE: 'Check Salt' & 'Inspect Cell' LED's may also be ON if the control is set for the wrong Cell type or the cell is unplugged.

Inspect the turbo cell.

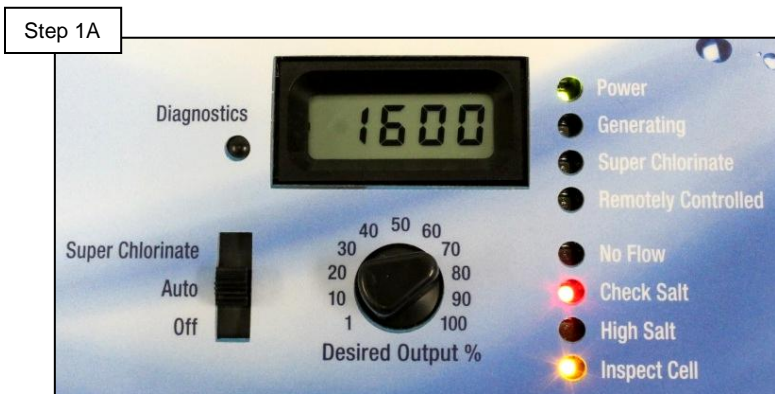

Test the salt level in the pool using an independent testing method. If the salt level is between 2700-3400ppm, go to step 1B. If salt level is below the recommended range, add enough salt to achieve a salt level of 3200ppm. (Refer to Salt Chart, Page 29).

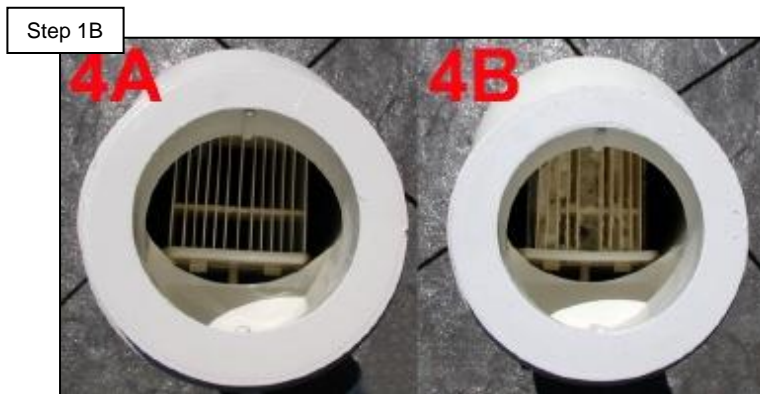

If cell looks like 4A, go to step C. If cell looks like 4B, clean cell. (Refer to Pages 17 thru 19). After the cell is clean go to step 1C to reset.

1. Check Salt & Inspect Cell LED flashing or ON

Note: Resetting the average salt must be done within 60 seconds after starting the process. To ensure both polarities are reading salt accurately (within 500ppm of the independent test), conduct this reset two times consecutively.

Step 1C

Step I

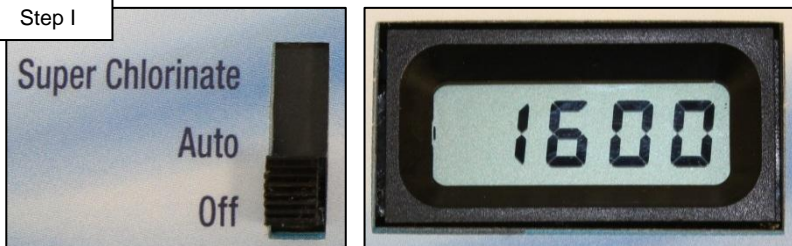

Starting with the average salt reading. Turn the switch to 'Off', then back to 'Auto'. Wait for the relay to click (about 5 to 10 seconds).

Step II

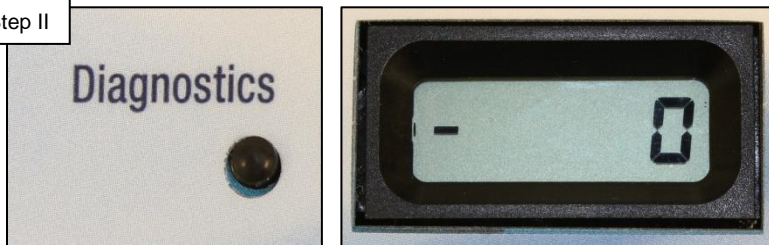

Press the 'Diagnostics' button 5 times, this will bring up the instant salt reading. The instant salt reading will start as -0. It will then fluctuate. Wait for the number to stabilize.

Step III

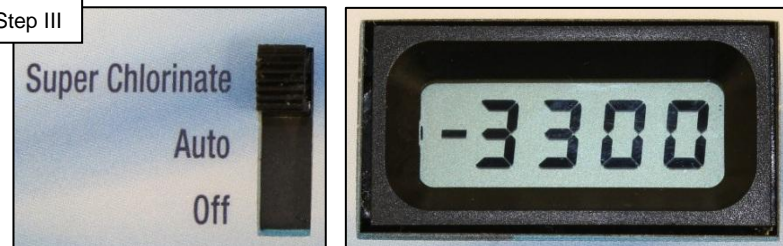

With the number stable (and the negative sign still present) move the switch to 'Super Chlorinate' then back to 'Auto'.

Step IV

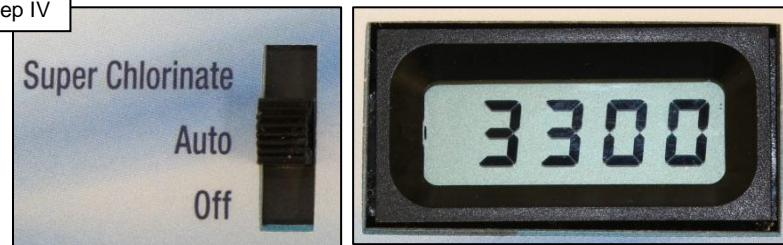

When the negative sign disappears, this number will reflect the new average salt reading. If value is not reading within 500ppm of independent test, then replace cell. If number is reading within 500ppm of the independent test and the 'Inspect Cell' LED is flashing, add salt until level is above 2700ppm.

How to Reset Average Salt Level

The Average Salt level needs to be reset for start up, when a board is replaced, when major adjustments are made to the pool water and when a cell is replaced. Note: new boards will display a factory default of 2800ppm.

Step I

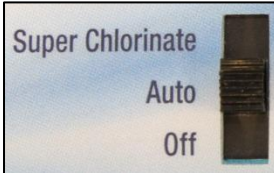
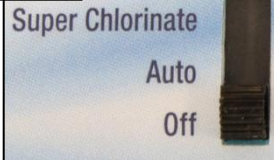

To reset, move the switch to 'Off' and then back to 'Auto'. Wait for the relay to click (5 to 10 seconds).

Step II



Press Diagnostics button 5 times to display the Instant Salt level. Wait for the number to stabilize.

Step III

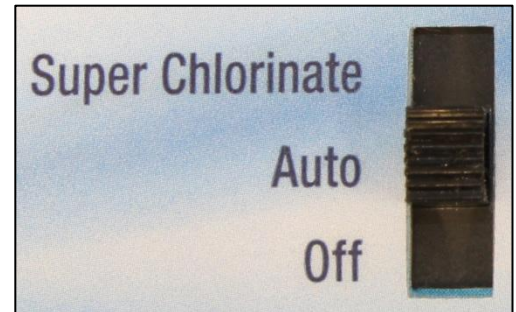

When the instant salt level is stable (and the negative sign still present), cycle slide switch to 'Super Chlorinate' and back to 'Auto'.

Adjusting Chlorine Output

Desired Output % Dial 1 to 100% sets the level of cell operation in % of operating time. Example: 50% (factory default) cell is operating and generating chlorine 50% of the total pump/filter operating time.

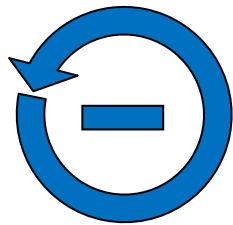

Rotate dial to the left to lower chlorine production.

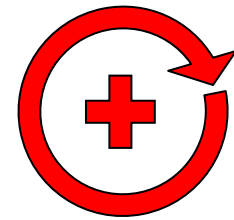
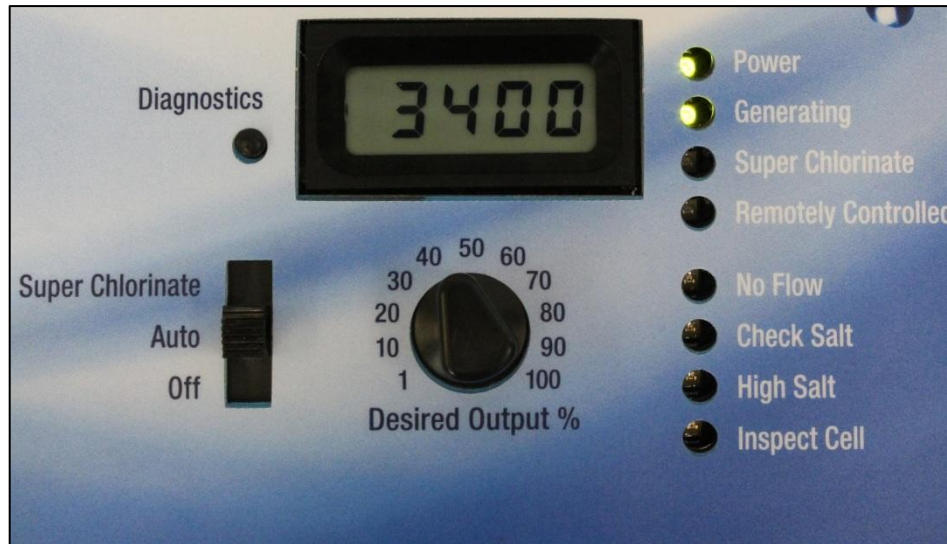

Rotate dial to the right to raise chlorine production.

Note: If the chlorine level does not increase within 24 hours after increasing output, test water with independent tests to determine current salt, stabilizer, phosphate, and nitrate levels. More information related to chlorine production on Page 30).

Note: Output is scaled back to 20% of desired output setting at 60° F and output stops at 50° F.

2. High Salt LED ON

The 'High Salt' LED will be ON when the cell amperage is above the maximum limit. The 'High Salt' LED may also be ON if the wrong Turbo Cell is being used. The Aqua Trol systems are designed to only work with the t-5 model. The LCD display will read 'HI' when the amperage is above 6.40.

Verify salt level is 2700-3400ppm and check with independent test to ensure accuracy.

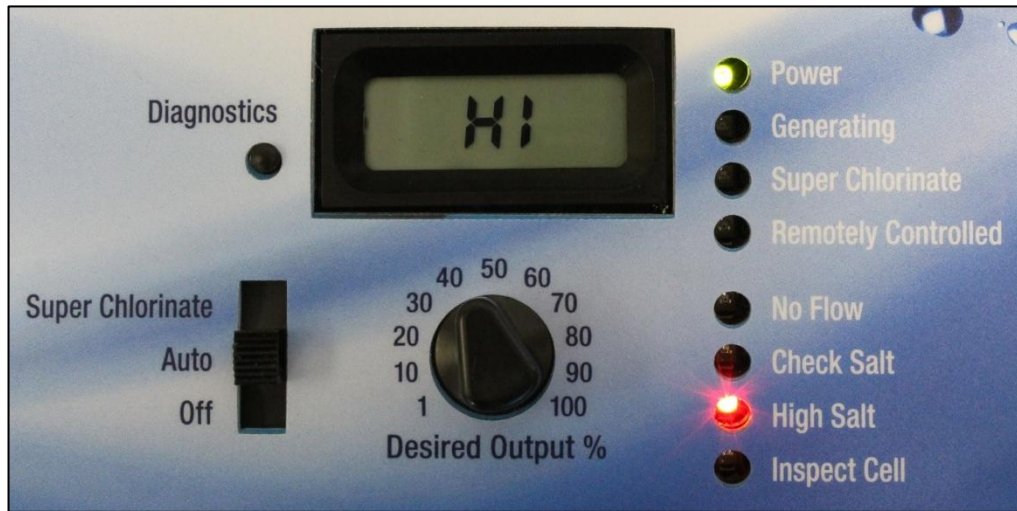

If salt level is above the range, partially drain pool and/or spa and refill with fresh water to achieve a salt level of 3200ppm, refer to page 9, Step D. If the salt level is not high, verify the correct cell is being used then reset (follow steps on page 6).

Unlike low salt the system does not shut the chlorinator down when a specific salt level is reached. Instead the unit will suspend chlorination when the cell's amperage draw exceeds a certain value.

**Maximum Current (Amps)
before shutdown**

T-CELL-5	6.40
----------	------

2. High Salt LED ON

To calculate how much water will need to be removed from a pool with too much salt, follow the formula provided below:

Step 2A

Part I

$$\frac{(\text{Ave. Pool Depth} \times 3200)}{\text{Actual Salt level in Pool}}$$

Part 1: Take the average depth of the pool in inches and multiply that by 3200. Then divide that number by the actual salt level in the pool (based on the independent test).

Part 2: Subtract the Ave. Pool Depth by the answer from part 1. This will give you the total number of inches to drain and replenish with fresh water to achieve a salt level of 3200.

Part II

$$\text{Ave. Pool Depth} - \text{Answer from Part 1} = \text{Amount of Water to Drain}$$

Example: a pool has an ave. depth of 54" and the salt level is 4500ppm

Example: Part I

$$54 \times 3200 = \frac{172800}{4500} = 38.4$$

Example: Part II

$$54 - 38.4 = 15.6''$$

Note: It is recommended to reduce the water level no more than six inches at a time before replenishing with fresh water. Failure to do so may result in damage to the pool structure or surface.

3. No Flow LED flashing or ON

*'No Flow' LED will flash for up to 60 seconds on start-up (when continuity through the switch is being detected).
'No Flow' LED will be ON if there is a problem with flow detection (when continuity through the switch is not being detected).*

Step 3A



If the 'No Flow' LED is flashing, make sure pump is primed and an adequate amount of water is passing through the flow switch element for at least 60 seconds (the required flow rate is 11 gpm). If after 60 seconds the LED does not go out proceed to step 3B.

If the 'No Flow' LED is ON make sure flow switch is plugged into the bottom of the control box and the wire is not damaged. If the wire or connector is damaged replace the switch, if not proceed to step 3B.

3. No Flow LED flashing or ON

Step 3B

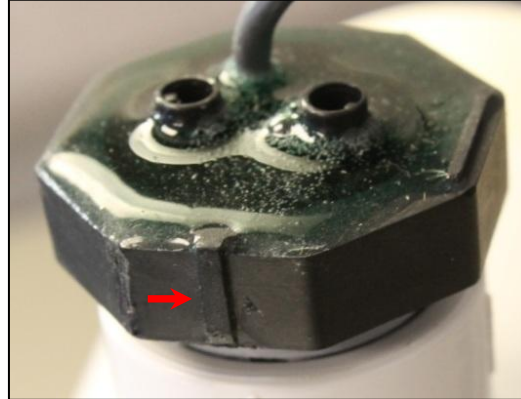
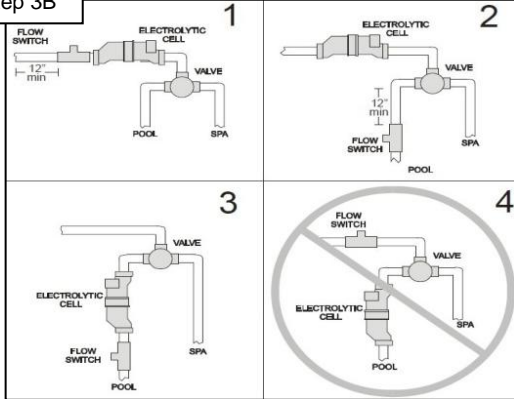

Verify the flow switch has 12" of straight pipe before it. If the flow switch is installed too close to an outlet/bend, re-plumb the switch to a location where it will not experience as much turbulence. Rotate the flow switch until the raised surface (on the hexagonal nut) is oriented against the flow of water. If this does not correct the problem (after 60 seconds) of consistent flow, proceed to Step 3C.

Step 3C

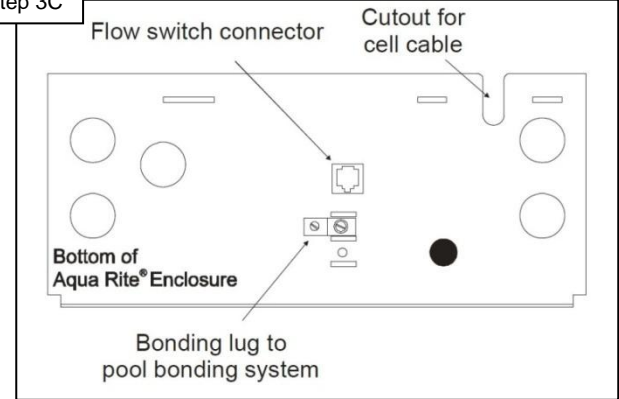

Verify that the control box (where the flow switch plugs in) is not corroded or damaged. If no damage is present on the board then replace the switch and repeat the 60 second filter delay after the pump is activated, if after 60 seconds the 'No Flow' LED does not go out replace the board.

4. Display Only, Lights Only or Neither

Verify 18-33 VDC between
black & red wires on main board

Step 4A

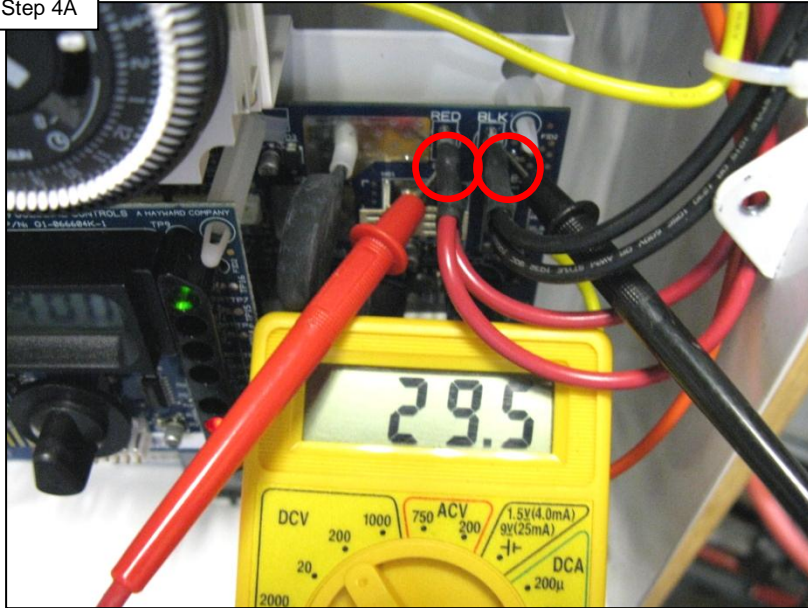

If no/low voltage, verify each wire is attached according to the instructions. If wire orientation is correct go to step 4C. If voltage OK, go to step 4B.

Reseat DSP Board

Step 4B

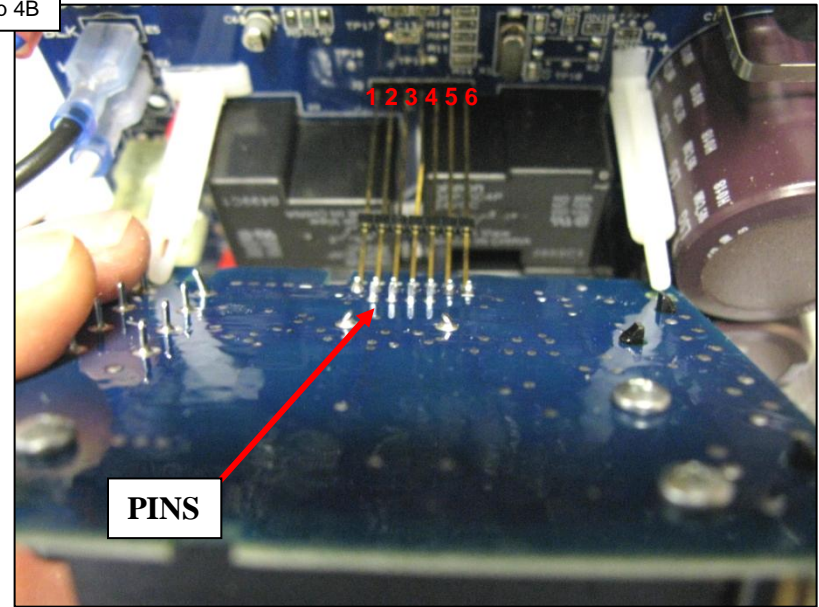

Remove and/or reseat DSP board. Pins may be shorted together or not making contact with connector. If pins are good, if volts are below 5VDC replace main board (GLX-PCB-TROL-(HP or RJ).

4. Display Only, Lights Only or Neither

Verify 115-125 VAC at input terminal TB1.

Step 4C

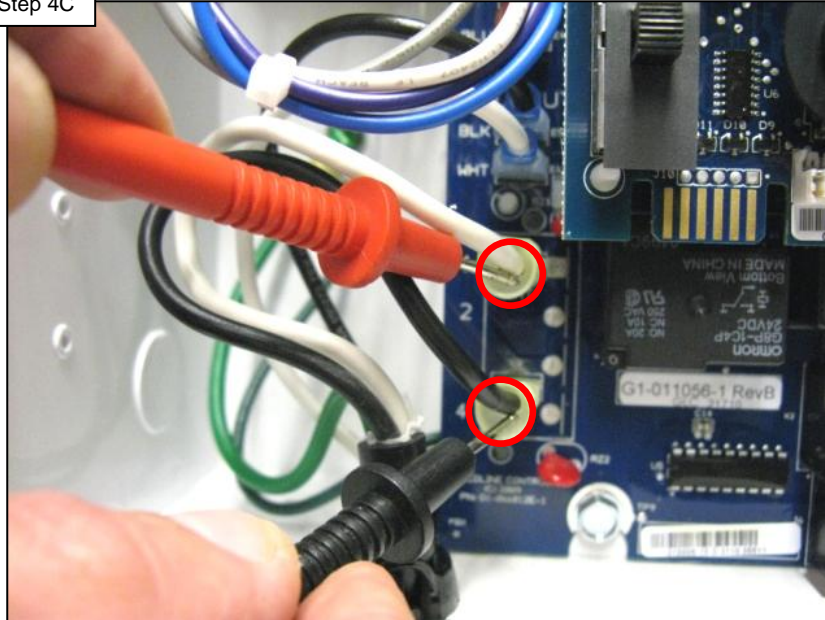

If voltage is correct, go to step 4D. If no voltage, verify that the GFCI or standard receptacle has power.

Verify 20-24 VAC between yellow wires

Step 4D

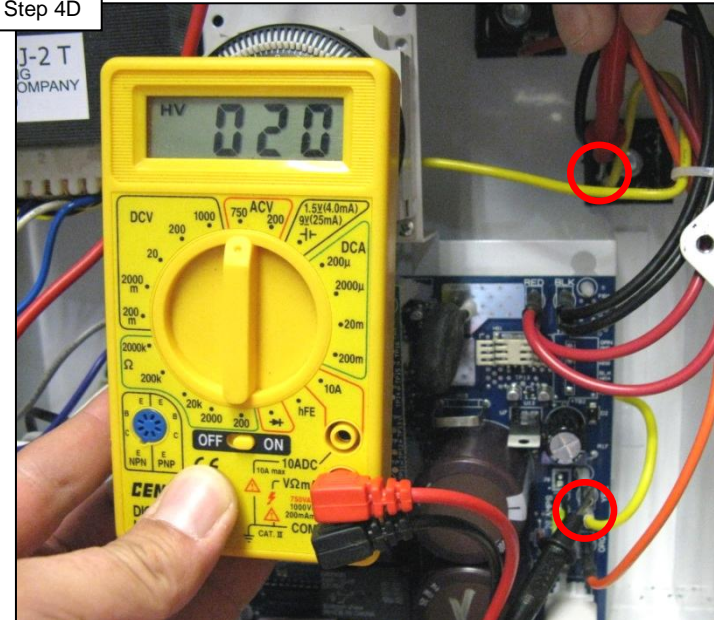

If voltage is good go to step 4F. If no/low voltage go to step 4E.

4. Display Only, Lights Only or Neither

**Shut off power to the control box.
Disconnect the blue, white, gray and
violet wires from the main board and measure
the following:**

Step 4E

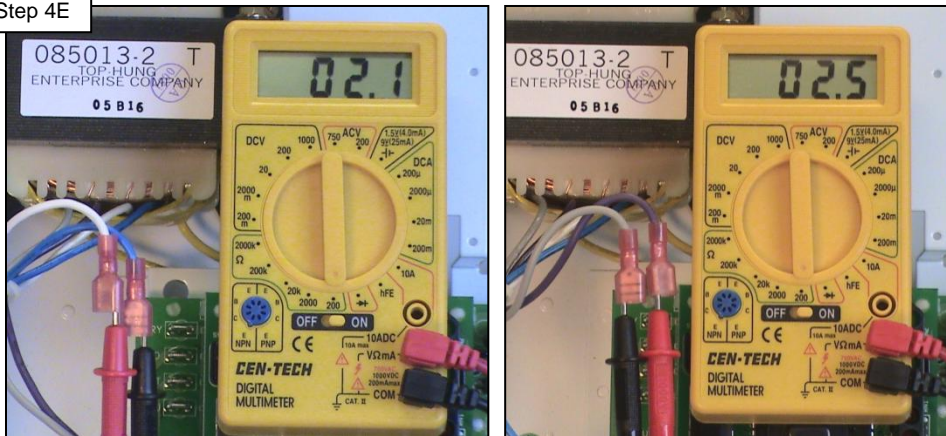

Insert probes and measure resistance between the Blue & White wires and the Violet & Gray wires. The readings should be 2.0-2.9 Ohms.

If the readings of either of the two measurements are not 2.0 – 2.9 Ohms, the transformer is faulty and should be replaced (GLX-XFMR). If measurements are OK, reconnect wires and go to step 4F.

**Test for continuity between
the two legs of the 20 amp
yellow ATO style fuse**

Step 4F

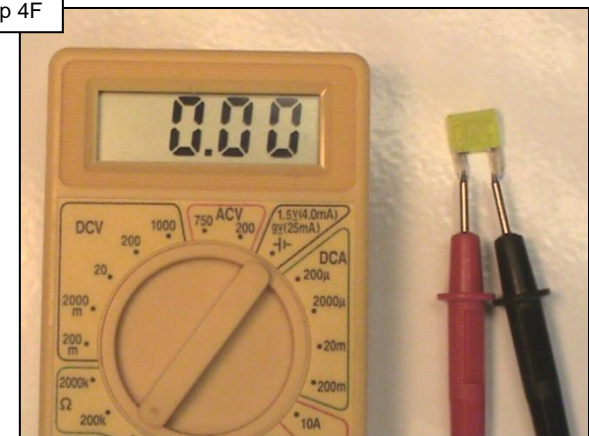

Replace fuse if blown. If fuse OK, go to step 4G.

4. Display Only, Lights Only or Neither

Verify 10-14 VAC between the Orange wire and the Green Grounding lug.

PCB-Trol (GLX-PCB-TROL-XX)

Step 4G

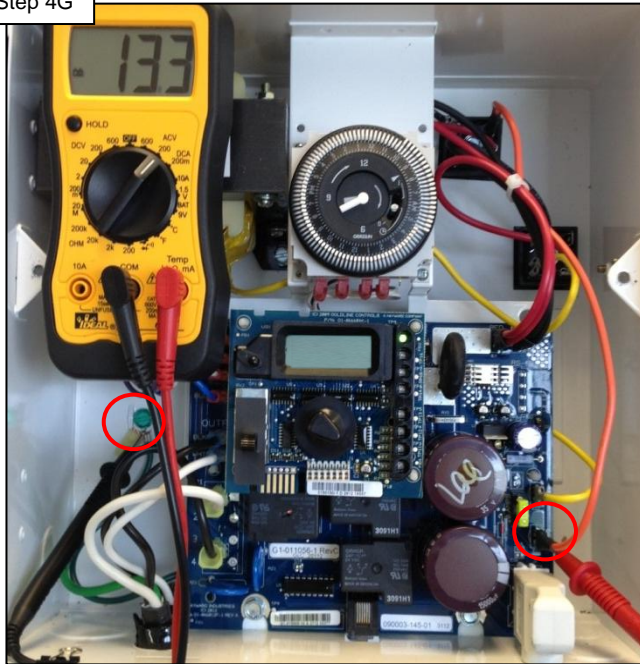

If no/low voltage, replace the main circuit board (GLX-PCB-TROL-XX). If voltage is correct, replace the rectifiers (GLX-DRK).



Rectifiers (GLX-DRK)



5. Low/High Cell temperature

The operating temperature range for the cell is 50° F to 140° F.

Verify actual water temperature

**Cell Temperature
Sensor**

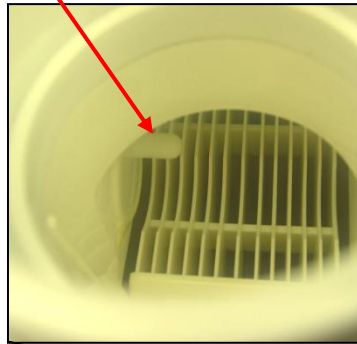

LCD display will read “COLD” when the water temperature is below 50° F
LCD display will read “HOT” when the water temperature is above 140° F
If the water temperature reads an erroneously high number, the cell temperature sensor is shorted and the cell needs to be replaced.

Output is scaled back to 20% at 60° F and output stops at 50° F

Cell Cleaning Instructions

Cell cleaning frequency is dependent on several factors; pH and calcium levels in the water are the two that have the greatest effect on how often the cell requires cleaning. Maintaining pH at the levels recommended in the Operating Instructions (7.2 - 7.8) should result in the cell being cleaned 3-4 times a year in areas with hard water. Cells may be cleaned less frequently in soft water areas.

After removing the Turbo Cell from the plumbing of your pool; inspect the cell for white deposits between the plates inside of the cell. Please remember that even if you cannot see deposits on the cell it still may need cleaning. If no deposits are found (4A), the cell may have to be held towards ample amounts of light and angled in different directions to reveal smaller white deposits deeper within the nest of the cell.

Hold to light to
look for small deposits

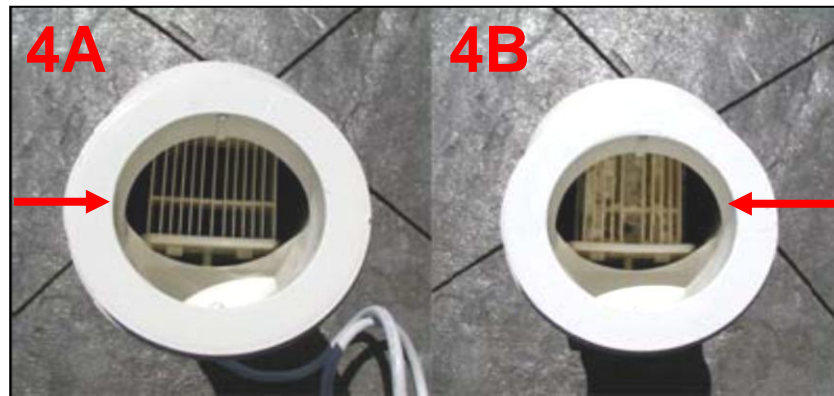

Cell is dirty.
Note the deposits.



CAUTION

ALWAYS ADD ACID TO WATER, NEVER WATER TO ACID. ALWAYS WEAR PROPER EYE PROTECTION AND PROTECTIVE GLOVES. USE IN A WELL VENTILATED AREA. MURIATIC AND OTHER ACIDS CAN CAUSE SEVERE INJURY, BURNS AND RESPIRATORY PROBLEMS IF NOT HANDLED PROPERLY. REFER TO THE MANUFACTURER'S DIRECTIONS FOR SAFE HANDLING.

Cell Cleaning Instructions

Cleaning instructions
using a container.



We strongly recommend using a Goldline Controls cell cleaning stand. (GLX-CELLSTAND)

Step 1: Use a water hose to dislodge small debris.

Step 2: Use a solution of water and Muriatic acid. Stand the cell vertically in the solution. Mix 1 part acid to 4 parts water. The level of the solution should be slightly over the product label. Let the cell stand in the solution for 15 minutes (Fig. 6A below), then flip the cell over and let stand on the other end (Fig. 6B below) for an additional 15 minutes. Although the cord can be submerged, be sure that the connector does not come in contact with the solution.

Inspect the cell after both sides have soaked. If there are no deposits after soaking, rinse with water and reinstall. If there are still deposits after soaking, repeat the soaking procedure until clean. The water/muriatic acid mixture can be stored for later use or it can be disposed. Follow chemical manufacturer's recommendations when storing or disposing the water/acid solution.

After you inspect the cell (and clean, if necessary) press the small "diagnostic" button next to the display for 3 seconds to stop the flashing "Inspect Cell" LED and reset the countdown timer for another 500 operational hours.



Cell Cleaning Instructions

Using the Goldline T-Cell Cleaning Stand

Follow the same safety and mixing instructions as described when using a container on page 14. Mix enough solution to fill the inside of the cell (Approximately 1.5 qts). Mix 1 part acid to 4 parts water.

Fasten the cell to the T-Cell Cleaning Stand with the cord side down (Fig. 6A below). Before filling cell with muriatic acid solution, put a container underneath to avoid any spills damaging the surrounding area. Fill the cell to the top with the solution and let soak for 15 minutes (Fig. 6B below). Empty the cell and inspect. If the cell is clean, rinse with water and reinstall. If there are still deposits after soaking, repeat the soaking procedure until clean. The water/muriatic acid mixture can be stored for later use or it can be disposed of. Follow the chemical manufacturer's recommendations when storing or disposing the water/acid solution.

After you inspect the cell (and clean, if necessary) press the small "diagnostic" button next to the display for 3 seconds to stop the flashing "Inspect Cell" LED and reset the countdown timer for another 500 operational hours. If the cell was cleaned because of 'Low Salt', be sure to reset the average salt reading by following the instructions on page 6.



6. Pump Not Turning On

Each tab represents 15 minutes there are 96 total tabs to make up 24 hours with of run time.

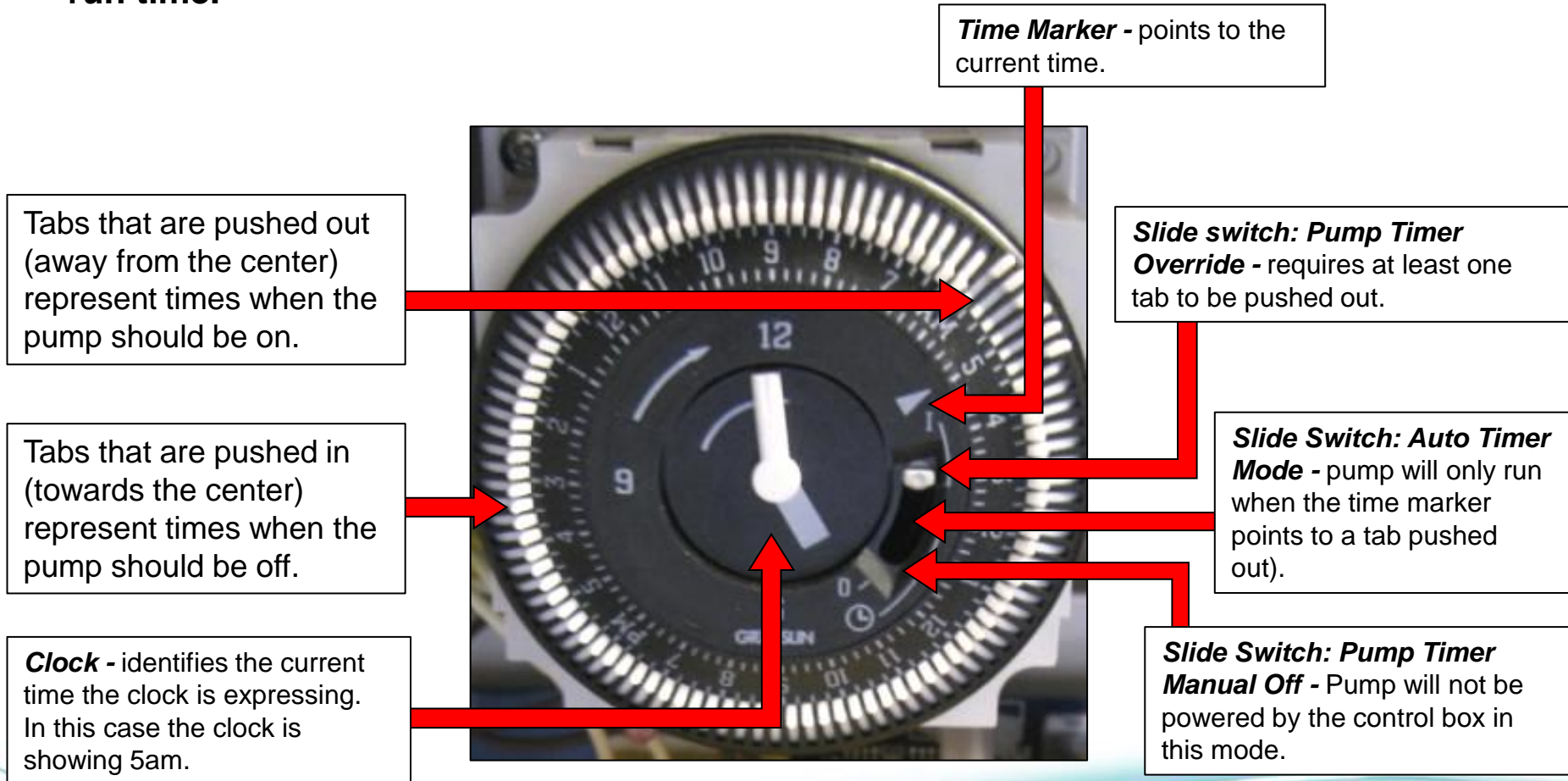

6. Pump Not Turning On

Verify correct model # is displayed. AL-6 for HP units, AL-7 for RJ units. Press the diagnostic button 6 times from the default screen to display the model #.

Step 7A



If not correct, replace PCB. Otherwise, proceed to Step 6B.

With the power switch in the center position and the trippers in "on position" (out), check for continuity between the brown wires at J1 on the PCB.

Step 7B



If no continuity exists, replace time clock. Otherwise, proceed to Step 6C.

6. Pump Not Turning On

With the trippers still in the “on position” check for 115 – 124 VAC between terminals E5 and E6 on the PCB.

Step 7C

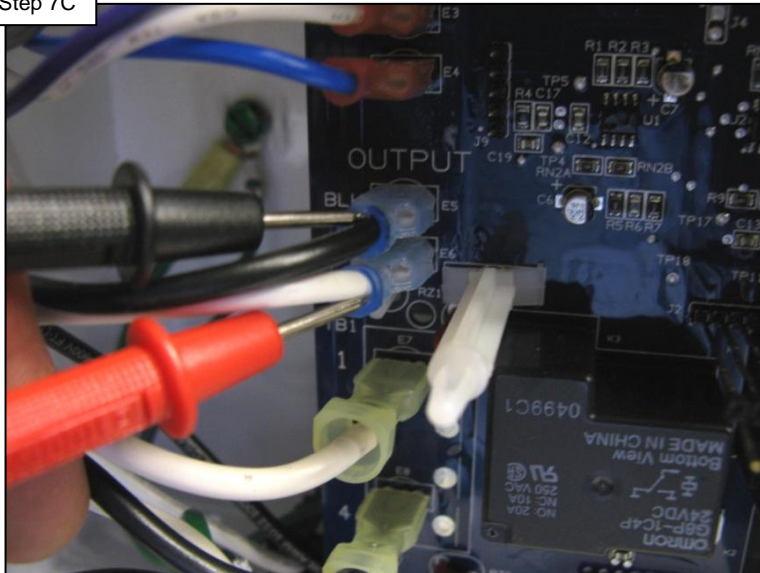

If voltage is not correct, replace the PCB.
Otherwise, proceed to Step 6D.

Verify 115-125 VAC is present at the pump receptacle on the bottom of the Trol.

Step 7D



If voltage is not correct, replace receptacle. Otherwise, the Trol is working correctly and the pump is where the problem lies.

Check Salt & Inspect Cell LED flashing or ON Troubleshooting Chart

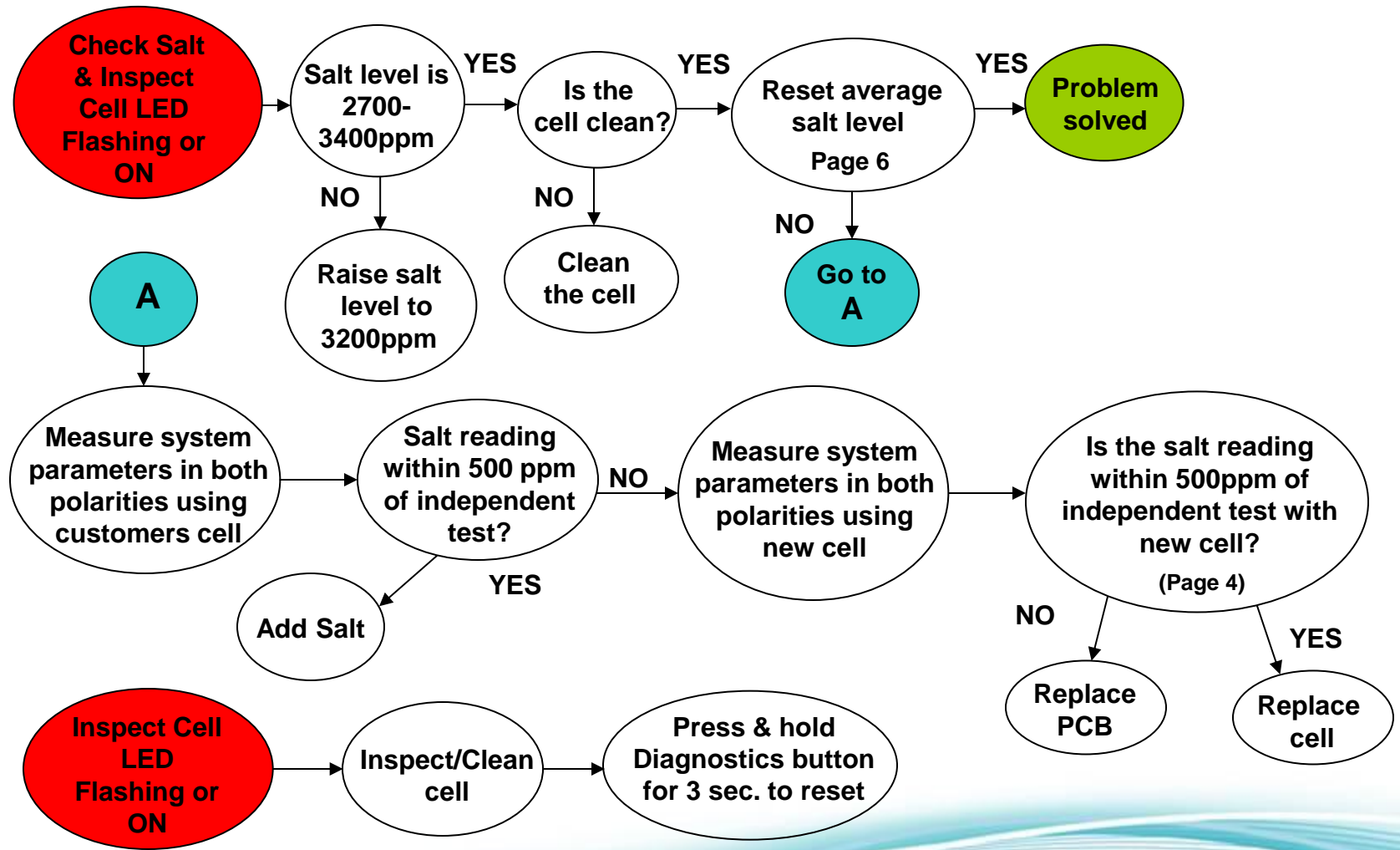

High Salt LED ON Troubleshooting Chart

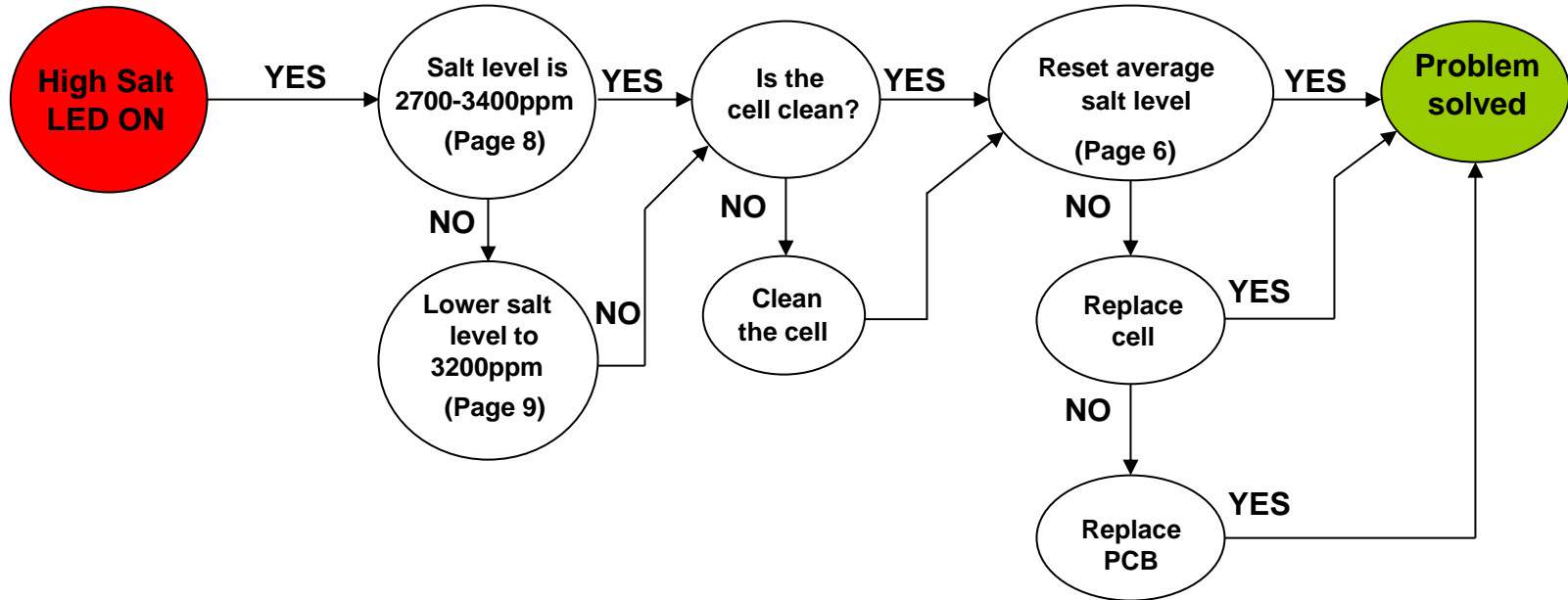

No Flow LED Flashing Troubleshooting Chart

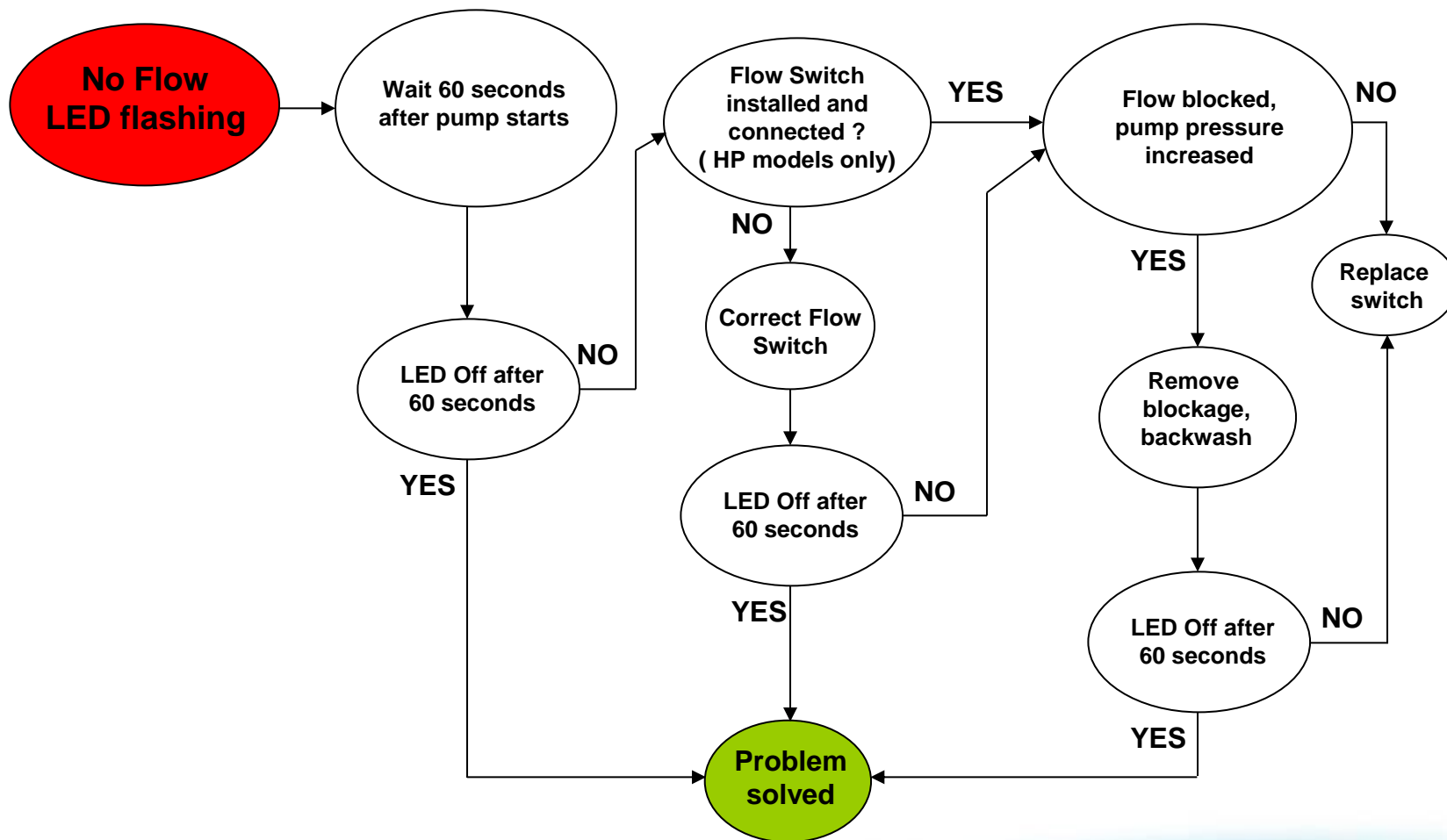

No Flow LED ON Troubleshooting Chart

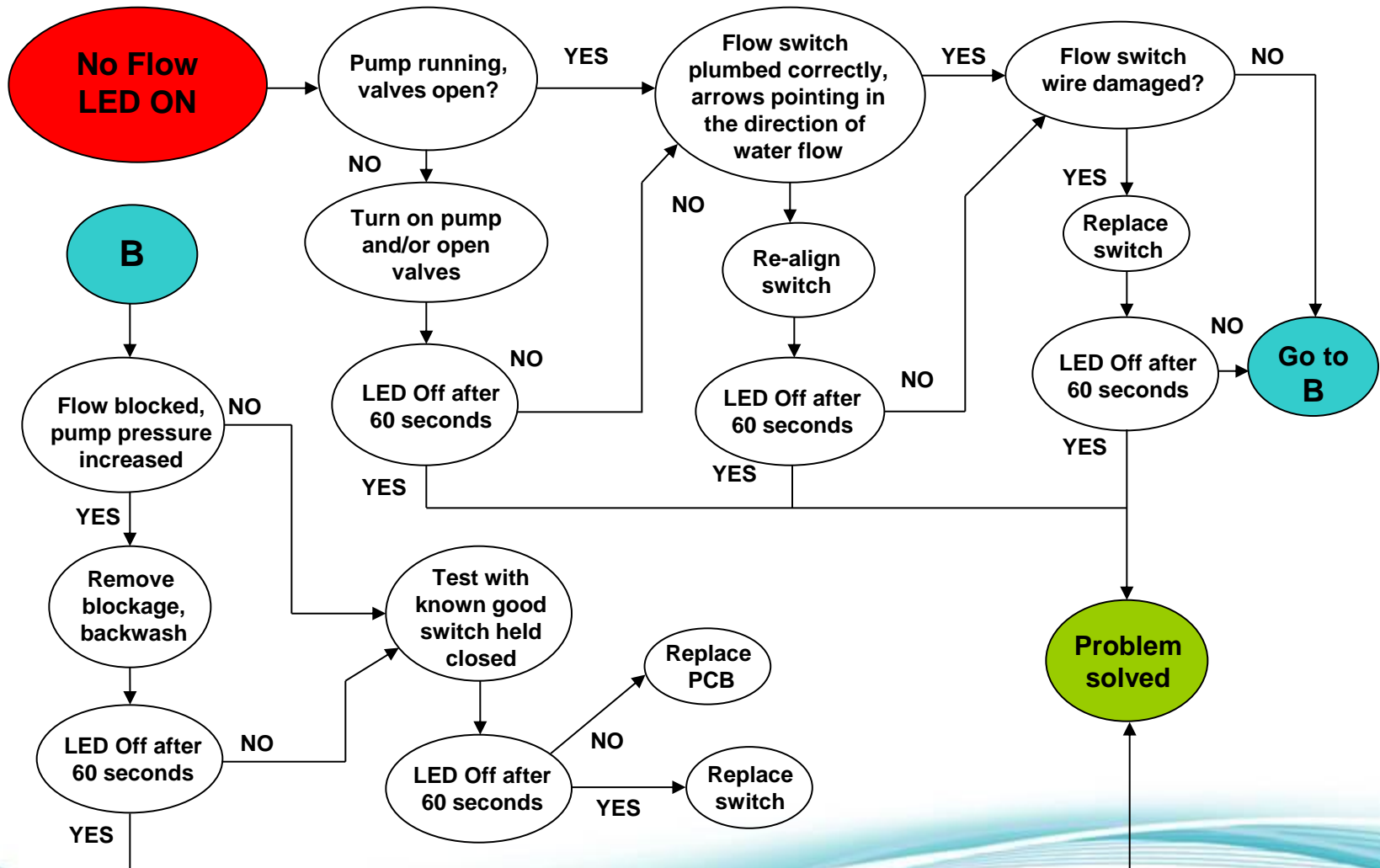

Pump Not Turning On Troubleshooting Chart

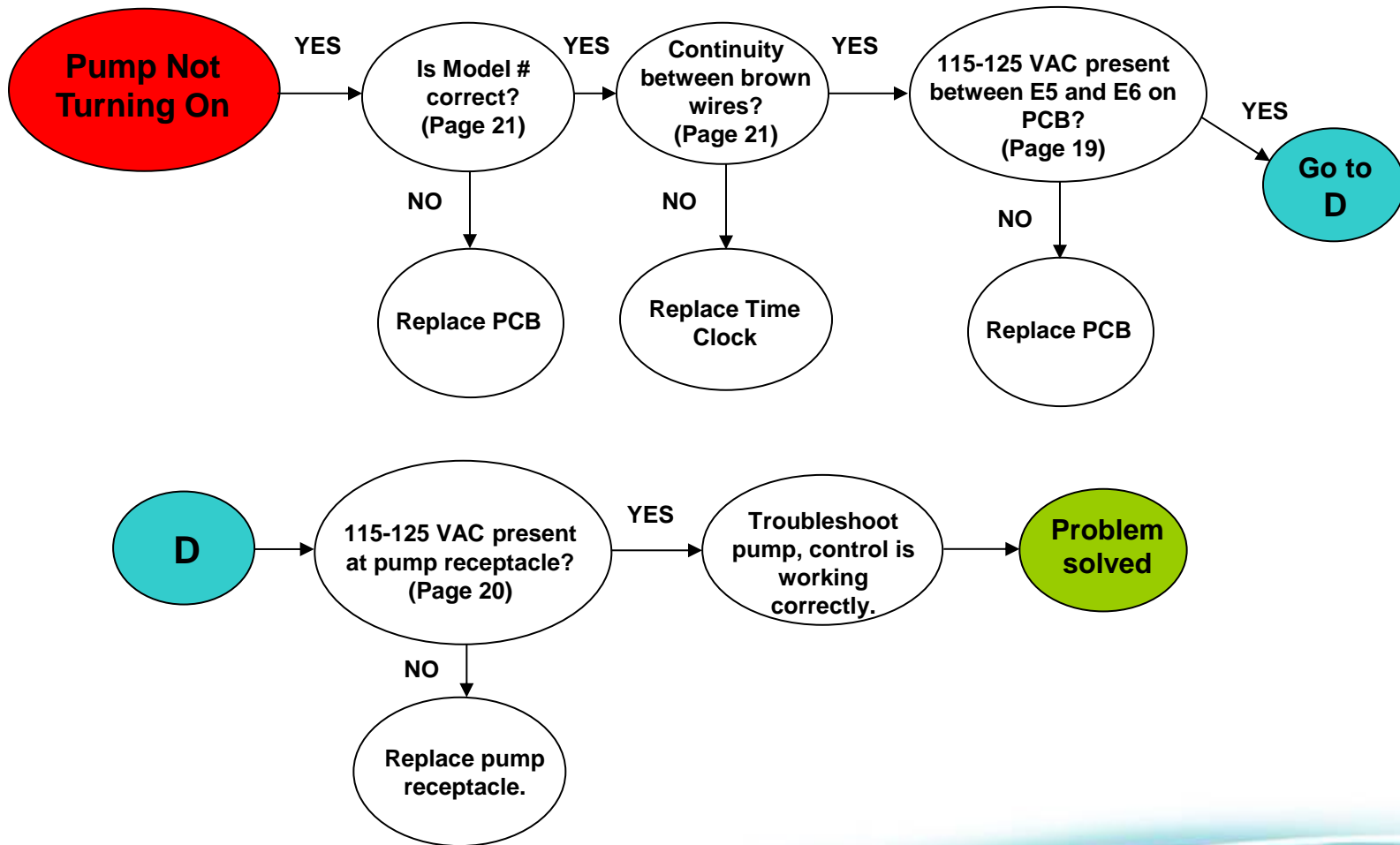

Salt Chart

Pounds of Salt required for 3200 ppm

Current Salt Level (ppm)	Pool Size -- Gallons																
	8,000	10,000	12,000	14,000	16,000	18,000	20,000	22,000	24,000	26,000	28,000	30,000	32,000	34,000	36,000	38,000	40,000
0	213	267	320	373	427	480	533	587	640	693	747	800	853	907	960	1013	1067
200	200	250	300	350	400	450	500	550	600	650	700	750	800	850	900	950	1000
400	187	233	280	327	373	420	467	513	560	607	653	700	747	793	840	887	933
600	173	217	260	303	347	390	433	477	520	563	607	650	693	737	780	823	867
800	160	200	240	280	320	360	400	440	480	520	560	600	640	680	720	760	800
1000	147	183	220	257	293	330	367	403	440	477	513	550	587	623	660	697	733
1200	133	167	200	233	267	300	333	367	400	433	467	500	533	567	600	633	667
1400	120	150	180	210	240	270	300	330	360	390	420	450	480	510	540	570	600
1600	107	133	160	187	213	240	267	293	320	347	373	400	427	453	480	507	533
1800	93	117	140	163	187	210	233	257	280	303	327	350	373	397	420	443	467
2000	80	100	120	140	160	180	200	220	240	260	280	300	320	340	360	380	400
2200	67	83	100	117	133	150	167	183	200	217	233	250	267	283	300	317	333
2400	53	67	80	93	107	120	133	147	160	173	187	200	213	227	240	253	267
2600	40	50	60	70	80	90	100	110	120	130	140	150	160	170	180	190	200
2800	27	33	40	47	53	60	67	73	80	87	93	100	107	113	120	127	133
3000	13	17	20	23	27	30	33	37	40	43	47	50	53	57	60	63	67
3200	ideal	ideal	ideal	ideal	ideal	ideal	ideal	ideal	ideal	ideal	ideal	ideal	ideal	ideal	ideal	ideal	ideal
3400	ok	ok	ok	ok	ok	ok	ok	ok	ok	ok	ok	ok	ok	ok	ok	ok	ok
3600+	dilute	dilute	dilute	dilute	dilute	dilute	dilute	dilute	dilute	dilute	dilute	dilute	dilute	dilute	dilute	dilute	dilute

Note: Prior to adding salt, always test water with independent tests to determine current salt and stabilizer levels.

How to Add Salt

Brushing the salt around will speed up the dissolving process. Do not allow the salt to sit in a pile at the bottom of the pool. Salt water is heavier than fresh water so the salt water will tend to accumulate at the deepest part of the pool. Run the filter system with the suction coming from the main drain for 24 hours to evenly distribute the salt throughout the pool.

Note: Allow 10-14 days for the plaster on new pools to cure before adding salt

IMPORTANT !!!

More on Chlorine Output & Salt Levels

1. The 'Pool Chlorinator %' and 'Spa Chlorinator %' options under the Setting Menu, control the level of salt cell operation as a percent of the total operating time of the filter pump. A simple example is that if the pump/filter is programmed to operate a total of 8 hours in a given day and the 'Pool Chlorinator %' is set to 50% the salt cell will operate (and produce chlorine) approximately half the time, or 4 hours.
2. The salt level that is calculated (and displayed) in the system is determined from several variables. It is possible that the displayed salt level can be significantly different from the actual salt level (when measured in the water with a tester). This can happen as a result of a dirty cell or from a cell that has began aging. Low salt should always require a cell cleaning first and then an actual meter measurement of the salt level in the water. If the cell is clean and the level of salt measured in the water is correct, then the cell has began to age, which results in a lower calculated salt level. This is an acceptable situation, assuming the level of free chlorine in the pool is appropriate. NEVER add additional salt in this circumstance.
3. If the free chlorine is not appropriate and the steps in item 2 have been followed and addressed as needed, then the 'Pool Chlorinator %' or 'Spa Chlorinator %' needs to be increased in a 25% increment (for example from 50% to 75%) to allow for the salt cell to operate for a longer period (% of total operating time) in order to produce a sufficient amount of chlorine as the cell begins to age. Allow 24 hours and re-test free chlorine. Increase in increments of +10% if required. Keep in mind this is assuming the chemistry parameters are correct in the water and there is nothing that is creating a significant chlorine demand.
4. Super-chlorinate is an additional option to use in order to 'catch up' in chlorine production when making adjustments to the desired output level. Enable 'Super Chlorinate' under the Settings Menu.

Reading Serial Numbers:

Beginning 08-05-2011

3A11284-123456

3A11284 = Standard Warranty Term

3A11284 = Product Family

3A11284 = Year of Manufacture

3A11284 = Day of Manufacture

123456 = Manufacturing ID

Beginning 11-01-2001

3A0112-123456

3A0112 = Standard Warranty Term

3A0112 = Product Family

3A0112 = Year of Manufacture

3A0112 = Month of Manufacture

123456 = Manufacturing ID